

Product data sheet

Specifications



variable speed drive ATV212 - 15kW - 20hp - 480V - 3ph - EMC - IP21

ATV212HD15N4

Product availability : Stock - Normally stocked in distribution facility

Main

| | |
|------------------------------|--|
| Device short name | ATV212 |
| Product destination | Asynchronous motors |
| Phase | 3 phase |
| Motor power kW | 15 kW |
| Maximum Horse Power Rating | 20 hp |
| Supply voltage limits | 323...528 V |
| Supply frequency | 50...60 Hz - 5...5 % |
| Line current | 22.8 A 480 V 28.5 A 380 V |
| Range of Product | Altivar 212 |
| Product or Component Type | Variable speed drive |
| Product Specific Application | Pumps and fans in HVAC |
| Communication port protocol | BACnet Modbus METASYS N2 APOGEE FLN LonWorks |
| [Us] rated supply voltage | 380...480 V - 15...10 % |
| EMC filter | Class C2 EMC filter integrated |
| IP degree of protection | IP21 |

Complementary

| | |
|------------------------------|---------------------------------------|
| Apparent power | 23.2 kVA 380 V |
| Continuous output current | 30.5 A 380 V 30.5 A 460 V |
| Maximum transient current | 33.6 A 60 s |
| Speed drive output frequency | 0.5...200 Hz |
| Speed range | 1...10 |
| Speed accuracy | +/- 10 % of nominal slip 0.2 Tn to Tn |
| Local signalling | for DC bus energized 1 LED (red) |
| Output voltage | <= power supply voltage |

* Price is "List Price" and may be subject to a trade discount – check with your local distributor or retailer for actual price.

| | |
|---|--|
| Isolation | Electrical between power and control |
| Type of cable | Without mounting kit 1 IEC cable 113 °F (45 °C), copper 90 °C / XLPE/EPR Without mounting kit 1 IEC cable 113 °F (45 °C), copper 70 °C / PVC With UL Type 1 kit 3 UL 508 cable 104 °F (40 °C), copper 75 °C / PVC |
| Electrical connection | VIA, VIB, FM, FLA, FLB, FLC, RY, RC, F, R, RES terminal 0.00 in ² (2.5 mm ²) / AWG 14 L1/R, L2/S, L3/T terminal 0.04 in ² (25 mm ²) / AWG 3 |
| Tightening torque | 5.31 lbf.in (0.6 N.m) VIA, VIB, FM, FLA, FLB, FLC, RY, RC, F, R, RES) 39.83 lbf.in (4.5 N.m), 40 lb.in L1/R, L2/S, L3/T) |
| Supply | Internal supply for reference potentiometer (1 to 10 kOhm) 10.5 V DC +/- 5 %, <10 A overload and short-circuit protection Internal supply 24 V DC 21...27 V), <200 A overload and short-circuit protection |
| Sampling duration | 2 ms +/- 0.5 ms F discrete 2 ms +/- 0.5 ms R discrete 2 ms +/- 0.5 ms RES discrete 3.5 ms +/- 0.5 ms VIA analog 22 ms +/- 0.5 ms VIB analog |
| Response time | FM 2 ms +/- 0.5 ms analog FLA, FLC 7 ms +/- 0.5 ms discrete FLB, FLC 7 ms +/- 0.5 ms discrete RY, RC 7 ms +/- 0.5 ms discrete |
| Accuracy | +/- 0.6 % VIA) for a temperature variation 60 °C +/- 0.6 % VIB) for a temperature variation 60 °C +/- 1 % FM) for a temperature variation 60 °C |
| Linearity error | VIA +/- 0.15 % of maximum value input VIB +/- 0.15 % of maximum value input FM +/- 0.2 % output |
| Analogue output type | FM switch-configurable voltage 0...10 V DC 7620 Ohm 10 bits FM switch-configurable current 0...20 mA 970 Ohm 10 bits |
| Discrete output type | Configurable relay logic FLA, FLC) NO - 100000 cycles Configurable relay logic FLB, FLC) NC - 100000 cycles Configurable relay logic RY, RC) NO - 100000 cycles |
| Minimum switching current | 3 mA 24 V DC configurable relay logic |
| Maximum switching current | 5 A 250 V AC resistive cos phi = 1 L/R = 0 ms FL, R) 5 A 30 V DC resistive cos phi = 1 L/R = 0 ms FL, R) 2 A 250 V AC inductive cos phi = 0.4 L/R = 7 ms FL, R) 2 A 30 V DC inductive cos phi = 0.4 L/R = 7 ms FL, R) |
| Discrete input type | F programmable 24 V DC level 1 PLC 4700 Ohm R programmable 24 V DC level 1 PLC 4700 Ohm RES programmable 24 V DC level 1 PLC 4700 Ohm |
| Discrete input logic | Positive logic (source) F, R, RES), <= 5 V, >= 11 V Negative logic (sink) F, R, RES), >= 16 V, <= 10 V |
| Dielectric strength | 3535 V DC between earth and power terminals 5092 V DC between control and power terminals |
| Insulation resistance | >= 1 mOhm 500 V DC for 1 minute |
| Frequency resolution | Display unit 0.1 Hz Analog input 0.024/50 Hz |
| Communication Service | Time out setting from 0.1 to 100 s Read device identification (43) Monitoring inhibitable Write single register (06) Write multiple registers (16) 2 words maximum Read holding registers (03) 2 words maximum |
| Option card | Communication card LonWorks |
| Power dissipation in W | 625 W |
| Air flow | 54420.42 Gal/hr(US) (206 m3/h) |
| Functionality | Mid |
| Specific application | HVAC |
| Variable speed drive application selection | Compressor for scroll Building - HVAC Fan Building - HVAC Pump Building - HVAC |
| Motor power range AC-3 | 15...25 kW 380...440 V 3 phase 15...25 kW 480...500 V 3 phase |
| Motor starter type | Variable speed drive |

| | |
|--|---|
| Discrete output number | 2 |
| Analogue input number | 2 |
| Analogue input type | VIA switch-configurable voltage 0...10 V DC 24 V max 30000 Ohm 10 bits VIB configurable voltage 0...10 V DC 24 V max 30000 Ohm 10 bits VIB configurable PTC probe 0...6 probes 1500 Ohm VIA switch-configurable current 0...20 mA 250 Ohm 10 bits |
| Analogue output number | 1 |
| Physical interface | 2-wire RS 485 |
| Connector Type | 1 open style 1 RJ45 |
| Transmission Rate | 9600 bps or 19200 bps |
| Transmission frame | RTU |
| Number of addresses | 1...247 |
| Data format | 8 bits, 1 stop, odd even or no configurable parity |
| Type of polarization | No impedance |
| Asynchronous motor control profile | Flux vector control without sensor, standard Voltage/frequency ratio, 2 points Voltage/frequency ratio, automatic IR compensation (U/f + automatic U ₀) Voltage/frequency ratio - Energy Saving, quadratic U/f Voltage/frequency ratio, 5 points |
| Torque accuracy | +/- 15 % |
| Transient overtorque | 120 % of nominal motor torque +/- 10 % 60 s |
| Acceleration and deceleration ramps | Linear adjustable separately from 0.01 to 3200 s Automatic based on the load |
| Motor slip compensation | Automatic whatever the load Not available in voltage/frequency ratio motor control Adjustable |
| Switching frequency | 6...16 kHz adjustable 12...16 kHz with derating factor |
| Nominal switching frequency | 12 kHz |
| Braking to standstill | By DC injection |
| Network Frequency | 47.5...63 Hz |
| Prospective line I_{sc} | 22 kA |
| Protection type | Overheating protection drive Thermal power stage drive Short-circuit between motor phases drive Input phase breaks drive Overcurrent between output phases and earth drive Overvoltages on the DC bus drive Break on the control circuit drive Against exceeding limit speed drive Line supply overvoltage and undervoltage drive Line supply undervoltage drive Against input phase loss drive Thermal protection motor Motor phase break motor With PTC probes motor |
| Width | 9.65 in (245 mm) |
| Height | 12.99 in (330 mm) |
| Depth | 7.48 in (190 mm) |
| Net Weight | 25.68 lb(US) (11.65 kg) |

Environment

| | |
|-------------------------|--|
| Pollution degree | 2 IEC 61800-5-1 IP20 on upper part without blanking plate on cover EN/IEC 61800-5-1 IP20 on upper part without blanking plate on cover EN/IEC 60529 IP21 EN/IEC 61800-5-1 IP21 EN/IEC 60529 IP41 on upper part EN/IEC 61800-5-1 |
|-------------------------|--|

IP41 on upper part EN/IEC 60529

| | |
|--|---|
| Vibration resistance | 1.5 mm 3...13 Hz)EN/IEC 60068-2-6 1 gn 13...200 Hz)EN/IEC 60068-2-8 |
| Shock resistance | 15 gn 11 ms IEC 60068-2-27 |
| Environmental characteristic | Classes 3C1 IEC 60721-3-3 Classes 3S2 IEC 60721-3-3 |
| Noise level | 54 dB 86/188/EEC |
| Operating altitude | 3280.84...9842.52 ft (1000...3000 m) limited to 2000 m for the Corner Grounded distribution network with current derating 1 % per 100 m <= 3280.84 ft (1000 m) without derating |
| Relative humidity | 5...95 % without condensation IEC 60068-2-3 5...95 % without dripping water IEC 60068-2-3 |
| Ambient air temperature for operation | 14...104 °F (-10...40 °C) without derating) 104...122 °F (40...50 °C) with derating factor) |
| Operating position | Vertical +/- 10 degree |
| Product Certifications | CSA UL C-tick NOM 117 |
| Marking | CE |
| Standards | IEC 61800-3 category C2 EN 61800-3 category C3 IEC 61800-3 category C3 IEC 61800-5-1 EN 61800-3 environments 2 category C1 EN 55011 class A group 1 IEC 61800-3 environments 2 category C2 EN 61800-3 environments 2 category C2 IEC 61800-3 environments 1 category C2 IEC 61800-3 environments 1 category C3 EN 61800-5-1 UL Type 1 IEC 61800-3 environments 2 category C3 EN 61800-3 category C2 EN 61800-3 environments 1 category C3 IEC 61800-3 EN 61800-3 environments 1 category C2 EN 61800-3 environments 2 category C3 IEC 61800-3 environments 1 category C1 EN 61800-3 IEC 61800-3 environments 2 category C1 EN 61800-3 environments 1 category C1 |
| Assembly style | With heat sink |
| Electromagnetic compatibility | Electrostatic discharge immunity test level 3 IEC 61000-4-2 Radiated radio-frequency electromagnetic field immunity test level 3 IEC 61000-4-3 Electrical fast transient/burst immunity test level 4 IEC 61000-4-4 1.2/50 µs - 8/20 µs surge immunity test level 3 IEC 61000-4-5 Conducted radio-frequency immunity test level 3 IEC 61000-4-6 Voltage dips and interruptions immunity test IEC 61000-4-11 |
| Regulation loop | Adjustable PI regulator |
| Ambient Air Temperature for Storage | -13...158 °F (-25...70 °C) |

Ordering and shipping details

| | |
|--------------------------|---------------------------------|
| Category | 22157-ATV212 1 - 25 HP 460 VOLT |
| Discount Schedule | CP4D |
| GTIN | 3606480322525 |
| Returnability | Yes |
| Country of origin | ID |

Packing Units

| | |
|-------------------------------------|-----|
| Unit Type of Package 1 | PCE |
| Number of Units in Package 1 | 1 |

| | |
|-------------------------------------|---------------------------|
| Package 1 Height | 10.83 in (27.5 cm) |
| Package 1 Width | 15.55 in (39.5 cm) |
| Package 1 Length | 11.81 in (30 cm) |
| Package 1 Weight | 25.45 lb(US) (11.544 kg) |
| Unit Type of Package 2 | P06 |
| Number of Units in Package 2 | 4 |
| Package 2 Height | 29.53 in (75 cm) |
| Package 2 Width | 23.62 in (60 cm) |
| Package 2 Length | 31.50 in (80 cm) |
| Package 2 Weight | 131.36 lb(US) (59.584 kg) |

Offer Sustainability

| | |
|-----------------------------------|---|
| Sustainable offer status | Green Premium product |
| California proposition 65 | WARNING: This product can expose you to chemicals including: Lead and lead compounds, which is known to the State of California to cause cancer and birth defects or other reproductive harm. For more information go to www.P65Warnings.ca.gov |
| REACH Regulation | REACH Declaration |
| EU RoHS Directive | Pro-active compliance (Product out of EU RoHS legal scope) EU RoHS Declaration |
| Mercury free | Yes |
| RoHS exemption information | Yes |
| China RoHS Regulation | China RoHS declaration |
| Environmental Disclosure | Product Environmental Profile |
| Circularity Profile | End of Life Information |
| WEEE | The product must be disposed on European Union markets following specific waste collection and never end up in rubbish bins. |

Contractual warranty

| | |
|-----------------|-----------|
| Warranty | 18 months |
|-----------------|-----------|

Dimensions

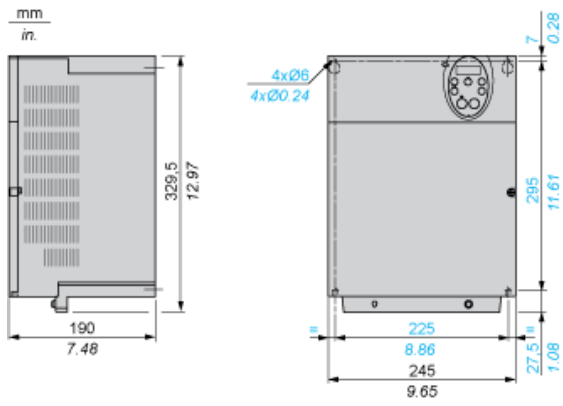
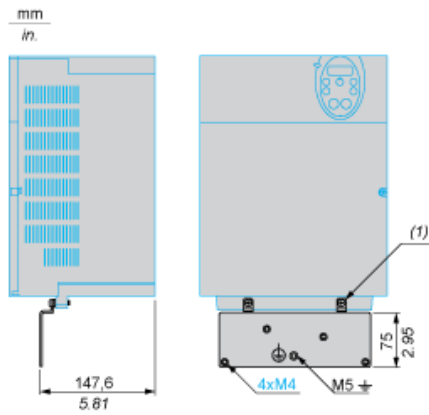

Plate for EMC mounting (supplied with the drive)



(1) 2 x M5 screws

Mounting Recommendations

Clearance

Depending on the conditions in which the drive is to be used, its installation will require certain precautions and the use of appropriate accessories.

Install the unit vertically:

- Do not place it close to heating elements.
- Leave sufficient free space to ensure that the air required for cooling purposes can circulate from bottom to the top of the unit.



Mounting Types

Type A mounting



Type B mounting



Type C mounting



By removing the protective blanking cover from the top of the drive, the degree of protection for the drive becomes IP21. The protective blanking cover may vary according to the drive model, see opposite.

Specific Recommendations for Mounting in an Enclosure

To help ensure proper air circulation in the drive:

- Fit ventilation grilles.
- Check that there is sufficient ventilation. If there is not, install a forced ventilation unit with a filter. The openings and/or fans must provide a flow rate a
- Use special filters with UL Type 12/IP54 protection.
- Remove the blanking cover from the top of the drive.

Sealed Metal Enclosure (IP54 Degree of Protection)

The drive must be mounted in a dust and damp proof enclosure in certain environmental conditions, such as dust, corrosive gases, high humidity with risk of condensation and dripping water, splashing liquid, etc. This enables the drive to be used in an enclosure where the maximum internal temperature reaches 50°C.

Recommended Wiring Diagram

3-Phase Power Supply



- A1:** ATV 212 drive
- KM1:** Contactor
- Q1:** Circuit breaker
- Q2:** GV2 L rated at twice the nominal primary current of T1
- Q3:** GB2CB05
- S1, S2:** XB4 B or XB5 A pushbuttons
- T1:** 100 VA transformer 220 V secondary
- (1)** Fault relay contacts for remote signalling of the drive status
- (2)** Connection of the common for the logic inputs depends on the positioning of the switch (Source, PLC, Sink)
- (3)** Reference potentiometer SZ1RV1202

NOTE: All terminals are located at the bottom of the drive. Install interference suppressors on all inductive circuits near the drive or connected on the same circuit, such as relays, contactors, solenoid valves, fluorescent lighting, etc.

Switches (Factory Settings)

Voltage/current selection for analog I/O (VIA and VIB)



Voltage/current selection for analog I/O (FM)



Selection of logic type

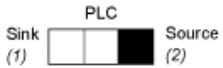

- (1)** negative logic
- (2)** positive logic

Other Possible Wiring Diagrams

Logic Inputs According to the Position of the Logic Type Switch

“Source” position



“Sink” position



“PLC” position with PLC transistor outputs



(1) PLC



(1) PLC

2-wire control

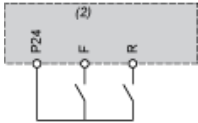

F: Forward
R: Preset speed
(2) ATV 212 control terminals

3-wire control

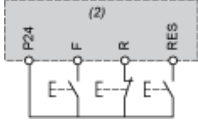

F: Forward
R: Stop
RES: Reverse
(2) ATV 212 control terminals

PTC probe

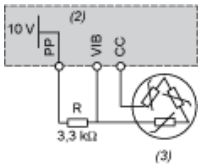

(2) ATV 212 control terminals
(3) Motor

Analog Inputs

Voltage analog inputs

External +10 V

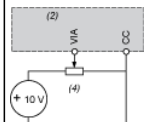

(2) ATV 212 control terminals
(4) Speed reference potentiometer 2.2 to 10 kΩ

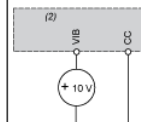

(2) ATV 212 control terminals

Analog input configured for current: 0-20 mA, 4-20 mA, X-Y mA

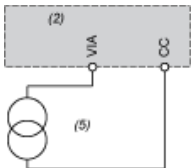

(2) ATV 212 control terminals
(5) Source 0-20 mA, 4-20 mA, X-Y mA

Analog input VIA configured as positive logic input ("Source" position)



(2) ATV 212 control terminals

Analog input VIA configured as negative logic input ("Sink" position)

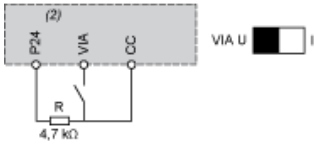

(2) ATV 212 control terminals

Derating Curves

The derating curves for the drive nominal current (I_n) depend on the temperature, the switching frequency and the mounting type (A, B or C). For intermediate temperatures (45°C for example), interpolate between 2 curves.

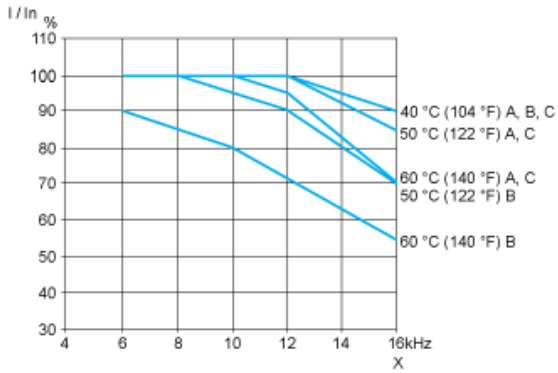

X Switching frequency